



Reaction to fire test report

Test standard: Ad-hoc test based off ISO 13785-1:2002

Test sponsor: Cladding Safety Victoria (CSV)

System: Aluminium composite panel (ACP) and glazing external wall cladding system

Job number: RTF230140

Test date: 21 February 2024 Revision: R1.0

Quality management

Revision	Date	Information about the report		
R2.0	31 May 2024	Description	Initial issue.	
		Name Signature	Prepared by	Reviewed by
			Authorised by	

Warringtonfire* Australia Pty Ltd
ABN 81 050 241 524

*As used herein, The name "Warringtonfire" and its associated IP and branding is used by Warringtonfire Australia Pty Limited in Australia under licence from Warringtonfire Testing and Certification Limited (based in the UK) for a transitional period following the acquisition of Warringtonfire Australia Pty Limited. The Warringtonfire Testing and Certification Limited continues to own the rights to "Warringtonfire" and continues to operate the global "Warringtonfire business" outside of Australia.

Contents

1.	Introduction.....	4
2.	Test specimen.....	4
2.1	Schedule of components.....	4
3.	Test procedure.....	9
4.	Test measurements and results	10
5.	Application of test results	19
5.1	Test limitations	19
5.2	Variations from the tested specimen.....	19
5.3	Uncertainty of measurements.....	19
Appendix A	Drawings of test assembly	20
Appendix B	Photographs.....	31
Appendix C	Chemical Analysis Results	44

1. Introduction

This report documents the findings of test one of three ad-hoc reaction to fire tests for an Aluminium composite panel (ACP) and glazing external wall cladding system performed on 21 February 2024. The test was based off some general requirements of ISO 13785-1:2002.

Warringtonfire performed the test at the request of the test sponsor listed in Table 1.

Table 1 Test sponsor details

Test sponsor	Address
Cladding Safety Victoria (CSV)	717 Bourke Street Docklands, VIC 3808 Australia

2. Test specimen

2.1 Schedule of components



Table 2 describes the test specimen and lists the schedule of components. These were provided by the representatives of the test sponsor and surveyed by Warringtonfire. All measurements were done by Warringtonfire – unless indicated otherwise.

Detailed drawings of the test specimen are provided in Appendix A.

Table 2 Schedule of components

Item	Description		
Cladding			
1.	Item name	Aluminium composite panel (ACP) panel	
	Product	Aluminium Composite Panel - 4 mm White Gloss/Grey	
	Manufacturer/Supplier	██████████	
	Note on Supply of Panel	On behalf of CSV, Warringtonfire acquired the ACPs with 100 % polyethylene core. To the best of Warringtonfire’s knowledge this is a custom production which the supplier doesn’t normally supply. The panels were provided on the basis that this was for research purposes and not any purpose other than fire testing.	
	Material	The material was nominated as panels consisting of two layers of aluminium sheets sandwiching a layer (core) with 100 % polyethylene (PE). Analysis conducted by the analytical centre of UNSW showed that the core consisted of polyethylene (PE) - found to be 96 % w/w - whilst the remainder of the material was found to be 3.3 % inert material. Refer to Appendix C for more detailed results.	
	Colour	Skins	Front skin – Gloss white Back skin – Light grey
		Core	Black
	Size	Total panel thickness – 4.0 mm Skin thickness – 0.5 mm (both) Uncut: 4.0 m × 1.22 m Refer to Appendix A for individual panel sizing details.	
	Batch	██████████	
Areal density	5.6 kg/m ² (measured)		

Item	Description	
2.	Item name	Back-pan
	Product	Nominally 0.9 mm thick Galvabond sheet, measured 0.6 mm
	Supplier	[REDACTED]
	Material	Galvanised steel
	Batch	[REDACTED]
	Size	1160 mm wide × 3700 mm tall, 0.6 mm thick – in segments.
Glazing		
3.	Item name	Double glazing
	Material	6 mm Clear Heat Strengthened\12B (Argon filled cavity) \6.5 HU
	Size (nominal)	1188 mm wide × 1800 mm tall × 6 mm/12 mm/6.5 mm with a 12 mm black spacer.
	Manufacturer/Supplier	[REDACTED]
	Batch	[REDACTED]
4.	Item name	Single glazing
	Material	6 mm Clear Heat Strengthened
	Size (nominal)	1182 mm wide × 1800 mm tall × 6 mm thick
	Manufacturer/Supplier	[REDACTED]
	Batch	[REDACTED]
Framing		
5.	Item name	Test rig frame - 90 × 90 SHS and 200 × 90 PFC frame
	Material	Painted steel
	Size	90 mm × 90 mm × 5 mm thick and 200 mm × 90 mm × 10 mm thick – refer to Figure 12.
6.	Item name	Aluminium curtain wall transom/mullions (rectangular hollow sections) – framing
	Material	Aluminium
	Size	65 mm to 70 mm wide × 116 mm deep × 3 mm thick.
	Manufacturer/Supplier	[REDACTED]
7.	Item name	Aluminium angles - framing
	Size	25 mm wide × 50 mm deep × 3 mm thick
	Material	Aluminium
	Manufacturer/Supplier	[REDACTED]
8.	Item name	Aluminium angles – for middle double back-pan unit.
	Size	25 mm wide × 50 mm deep × 3 mm thick
	Material	Aluminium
	Manufacturer/Supplier	[REDACTED]
	Installation	Used to secure the secondary back-pan within the middle module. The angle was screw fixed to both the back-pan (item 1) and the aluminium framing (item 6) using screws (item 18).

Item	Description	
9.	Item name	Aluminium stiffener - framing
	Size	3 mm thick × 150 mm deep
	Material	Aluminium
	Manufacturer/Supplier	██████████
10.	Item name	Curtain wall bracket
	Size	150 mm deep (7 mm thick) × 75 tall (10 mm thick) × 100 mm wide
	Installation	Used to secure the 3 modules to the test rig using tek screws.
Smoke seal		
11.	Item name	Smoke seal
	Size	0.55 mm thick galvanised steel
	Manufacturer/Supplier	██████████
Penetration		
12.	Item name	Exhaust
	Size	Backing plates: 355 mm × 355 mm × 0.6 mm thick Large tube: Ø150 mm × 600 mm long × 0.5 mm thick Cap: Ø240 mm × 85 mm deep × 0.6 mm thick Connecting strips: 45 mm × 5 mm wide × 0.5 mm thick
	Material	Galvanised steel
	Manufacturer/Supplier	██████████
	Pictures	  <p style="text-align: center;">Exposed side Unexposed side</p>
	Installation	The penetrating element was a galvanised steel tube. On the glazing side was a circular weather cowl. A square compartment made from galvanised steel which hid the tubing was installed between the glazing and the inner back-pan.
Insulation		
13.	Item name	90 mm thick polyethylene terephthalate (PET) insulation
	Density	10 kg/m ³
	Manufacturer/Supplier	██████████
14.	Item name	50 mm thick aluminium - with fibre-glass mesh - foil faced rockwool insulation
	Density of core	40 kg/m ³
	Manufacturer/Supplier	██████████
Sealant/Adhesive		
15.	Item name	Weathering sealant - silicone sealant
	Product name	██████████

Item	Description	
	Manufacturer/Supplier	██████████
	Usage	Placed at ACP edges and screw and rivet locations.
16.	Item name	Back-pan sealant - Fire-rated mastic
	Product name	██████████
	Manufacturer/Supplier	██████████
	Usage	Used between the back-pans (item 1) and the aluminium framing (item 7).
17.	Item name	Penetration sealant
	Product name	██████████
	Manufacturer/Supplier	██████████
	Usage	Used between the back-pans (item 1) and the aluminium framing (item 7).
Fixings		
18.	Item name	Tek screws SDS – zinc coated steel – for fixing the back-pan
	Size	10g × 24 mm long
	Installation	Used to fix aluminium angles (item 8) to the aluminium frame (item 6) at max. 500 mm centres
19.	Item name	Wafer head screws – zinc coated steel
	Size	10g × 16 mm long
	Installation	Used to fix aluminium angles (item 8) to the aluminium frame (item 6) at max. 500 mm centres
20.	Item name	Wafer head screws – zinc coated steel
	Size	10g × 20 mm long
	Installation	Used to fix the penetration backing plate (item 12) to the back-pan (item 2) of the central module.
21.	Item name	Wafer head screws – zinc coated steel
	Size	10g × 21 mm long
	Installation	Used to fix ACP (item 1) to the aluminium stiffener (item 9) – four per corner.
22.	Item name	Aluminium rivets
	Size	Ø4 mm
23.	Item name	Fast-fix washers and pin weld (to hold insulation)
	Size	115 mm × 3 mm pins and 25 mm × 25 mm fast fix washers.
24.	Item name	Tek screws for curtain wall bracket
	Size	14 g × 35 mm long
25.	Item name	Tek screws for smoke seal to false slab i.e. C-Purlin
	Size	14 g × 35 mm long
Installation method		
Test rig:	The test rig frame (item 5) was the main support for the test specimen, however, there were two C-purlin sections that acted as false slabs (200 mm tall). The test specimen, 3-off modules – interconnected through aluminium framing (item 6), was fixed to the test rig using curtain wall brackets (item 10) and fixings (item 24) – see Figure 14 & Figure 16. Each module extended from the bottom of the specimen to the top.	

Item	Description
Framing:	The main framing for the external wall was composed of aluminium extrusions (item 6) which were screw fixed together. Aluminium angles (item 8) – horizontal edges - and stiffeners (item 9) – on the vertical edges - were fixed to the aluminium framing (item 6), using wafer head screws (item 20) and aluminium rivets (item 22), respectively.
Cladding:	<p>The front face of the specimen was cladded with casseted ACPs (item 1), which were fixed to the aluminium stiffeners (item 9) and the aluminium angles (item 8) using aluminium rivets (item 22), 2-off at 300 mm centres. See Figure 13 for panel locations.</p> <p>The back side of the framing was closed off with steel back-pans (item 1) screw fixed (item 18) at 300 mm centres. PET insulation (item 13) was fixed to the back-pan using fast-fix washers and pin combinations (item 19) that were welded to the back-pan. The centre module had an extra back-pan behind the glazing (item 4). This was fixed to the aluminium framing (item 6) using screws (item 18) and aluminium angles (item 8). Foil-faced rockwool insulation (item 14) was inserted between the two back-pans (item 1) of the centre module.</p>
Glazing	The glazing, both double (item 3) and single (item 4), were attached to the aluminium framing (item 6) as shown in Figure 13 to Figure 23 and Figure 26. The glazing was sealed around the perimeter with weather sealant (item 15).
Smoke seal	Smoke seal barrier (item 11) was attached to C-purlins of the test rig (item 5) with screw fixings (item 24) at approximate 600 mm centres. PET insulation (item 13) was installed into the 60 mm wide cavity above the barrier (item 12).
Penetration	The penetration went through holes in the single glazing (item 4) and back-pans (item 1) of the second module. These were fixed to the back-pan and the window with a steel sheet (backing plate), using screws and sealant and just sealant, respectively.

3. Test procedure

Table 3 details the test procedure for this reaction to fire test.

Table 3 Test procedure

Item	Detail
Statement of compliance	The ad-hoc test – which was based off ISO 13785-1:2002 - was performed to determine the reaction to fire performance of an external wall cladding when exposed to heat from a simulated external fire with flames impinging directly upon a façade. The test utilises a burner used in ISO 13785-1:2002.
Sampling / specimen selection	The laboratory was not involved in sampling or selecting the test specimen for the reaction to fire test. The results obtained during the test only apply to the test samples as received and tested by Warringtonfire.
Test duration	60 minutes
Instrumentation and equipment	<ul style="list-style-type: none"> • 21 mineral insulated metal sheathed (MIMS) Type K thermocouples with an overall diameter of 1.5 mm with the measuring junction insulated from the sheath were positioned 60 mm in front of the outer ACP face of the test specimen. Refer to Figure 1 for details on positioning. • The incident heat flux on the top of the specimen in line with the front face of test specimen was measured using a Schmidt-Boelter type heat flux gauge with a range of 0-20 kW/m². • The incident heat flux 500 mm behind the outer glazing's – burner side and non-burner side – was measured using two Schmidt-Boelter type heat flux gauges with a range of 0-20 kW/m². • The incident heat flux 80 mm behind the central glazing was measured using a Schmidt-Boelter type heat flux gauge with a range of 0-20 kW/m². • Temperatures above and below the cladding were measured by seven 100 mm × 100 mm × 0.7 mm plate thermocouples with mineral insulated metal sheathed (MIMS) Type K thermocouples with an overall diameter of 1 mm with the measuring junction electrically insulated from the sheath. The thermocouple hot junction was fixed to the geometric centre of the plate by a small steel strip made from the same material as the plate. The plate thermocouples included 97 mm × 97 mm × 10 mm inorganic insulation pads. Before the first use of the plate thermocouples, they were aged by being exposed to heat in a fire-resistance test furnace for 90 min under the standard temperature/ time curve. Refer to Figure 1 for details on positioning. • The fire source was a propane (95% purity) gas burner 1.2 m long × 0.1 m deep × 0.15 m tall. The burner was placed on the floor below the specimen with approximately 15 mm overlap with the ACP.
Test procedure	<ul style="list-style-type: none"> • At least two minutes of baseline data was collected prior to burner ignition. Temperature and heat flux data was collected at 5 s intervals. • The heat output from the burner was held at 300 kW for the 30 minutes. The burner was then turned off and data recorded for the next 30 minutes.
Test number	<ul style="list-style-type: none"> • Test one of three.
Variation to reference test RTF220102	<ul style="list-style-type: none"> • The cladding used for this test was different to the cladding used in RTF220102. • The duct capping used during the test was of a different shape to the one used in RTF220102. • The glazing used for this test varies slightly to the glazing used for RTF220102. • The laboratory conditions during the tests may differ.

4. Test measurements and results

The results from the tests are summarized below. Photographs of the specimen are included in Appendix B.

■ HFG
 □ Plate TC
 • 1.5 mm MIMS TCs

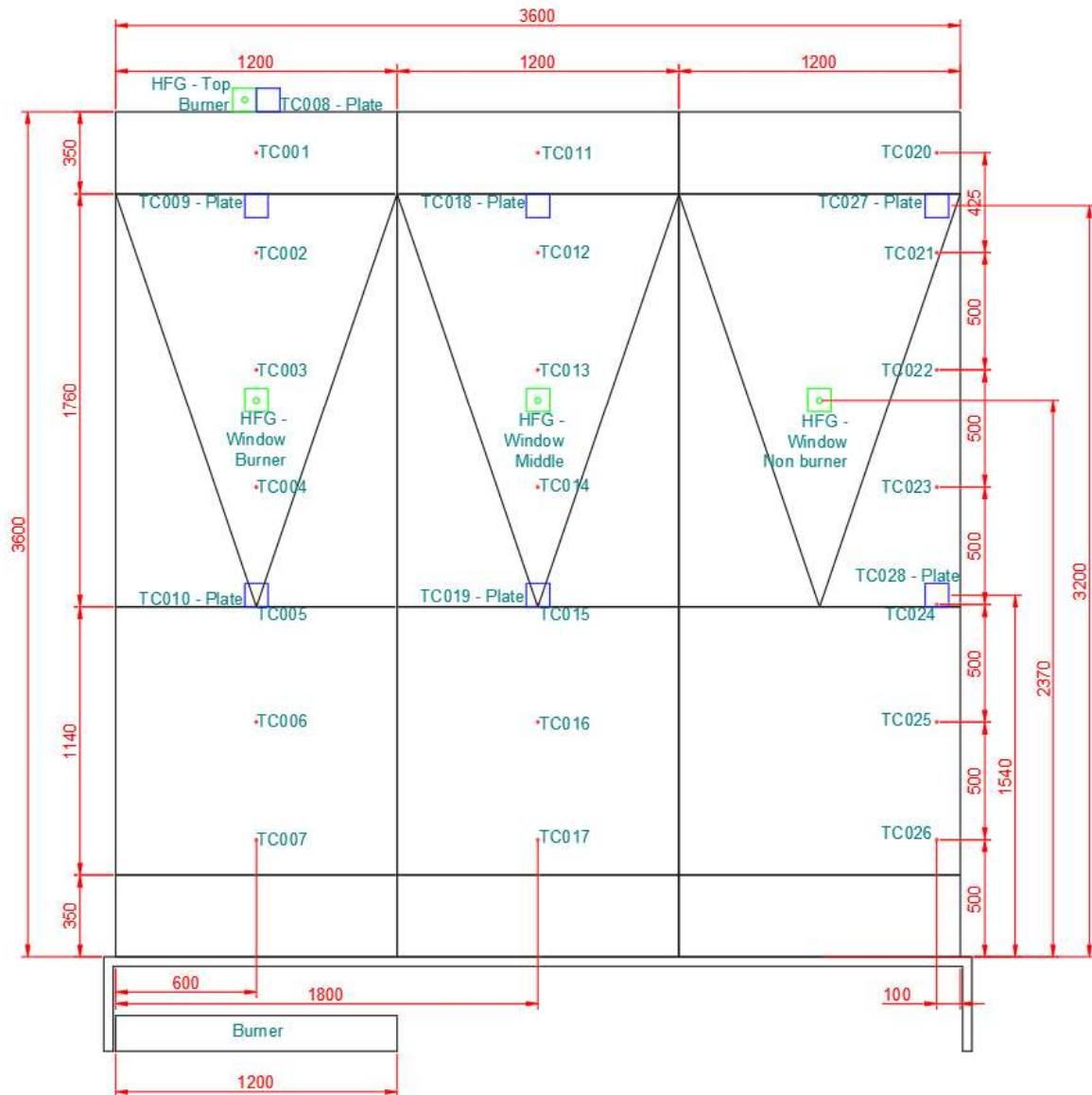

Figure 1 Instrumentation locations – front elevation

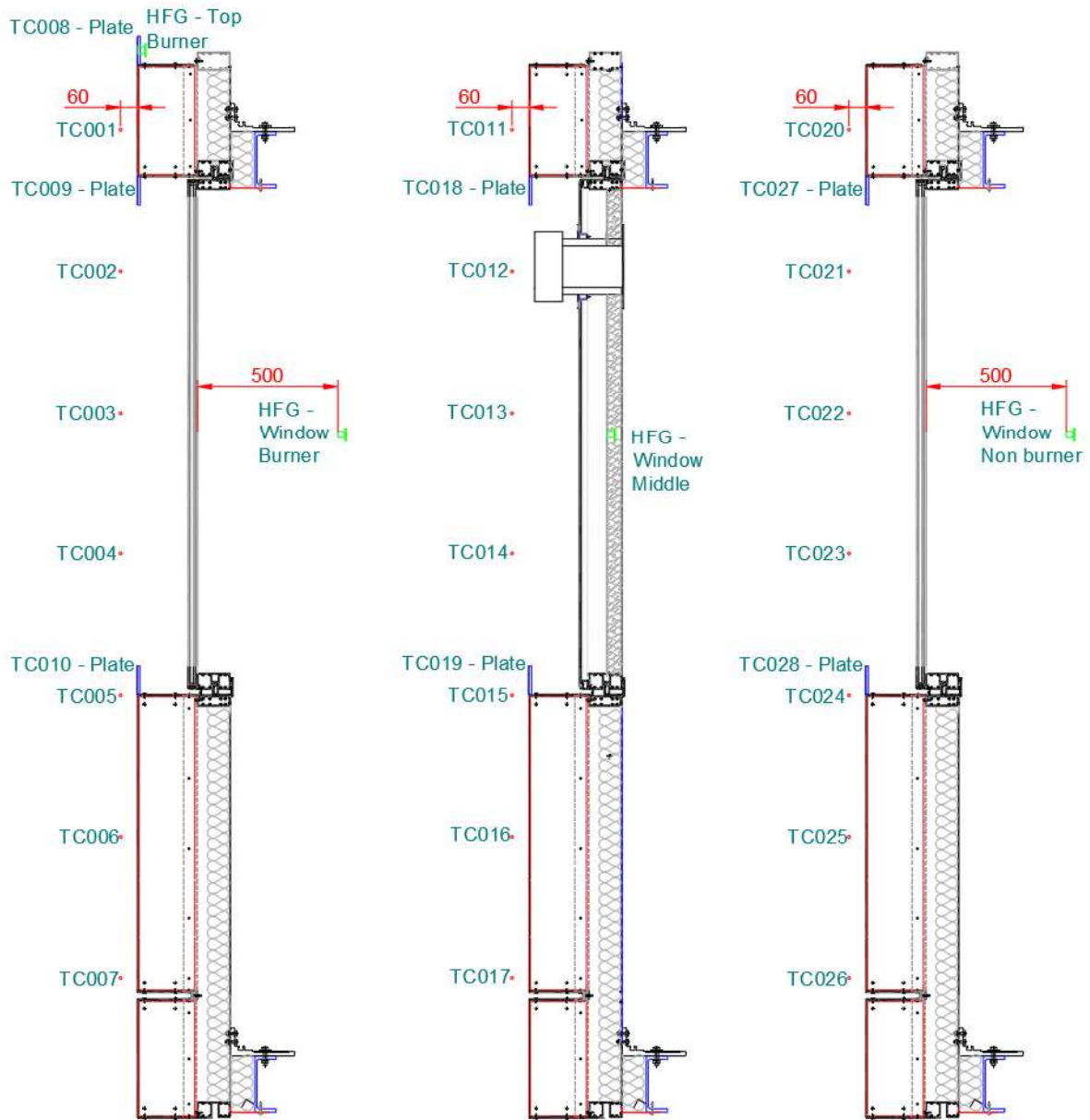

Figure 2 Instrumentation locations – sections

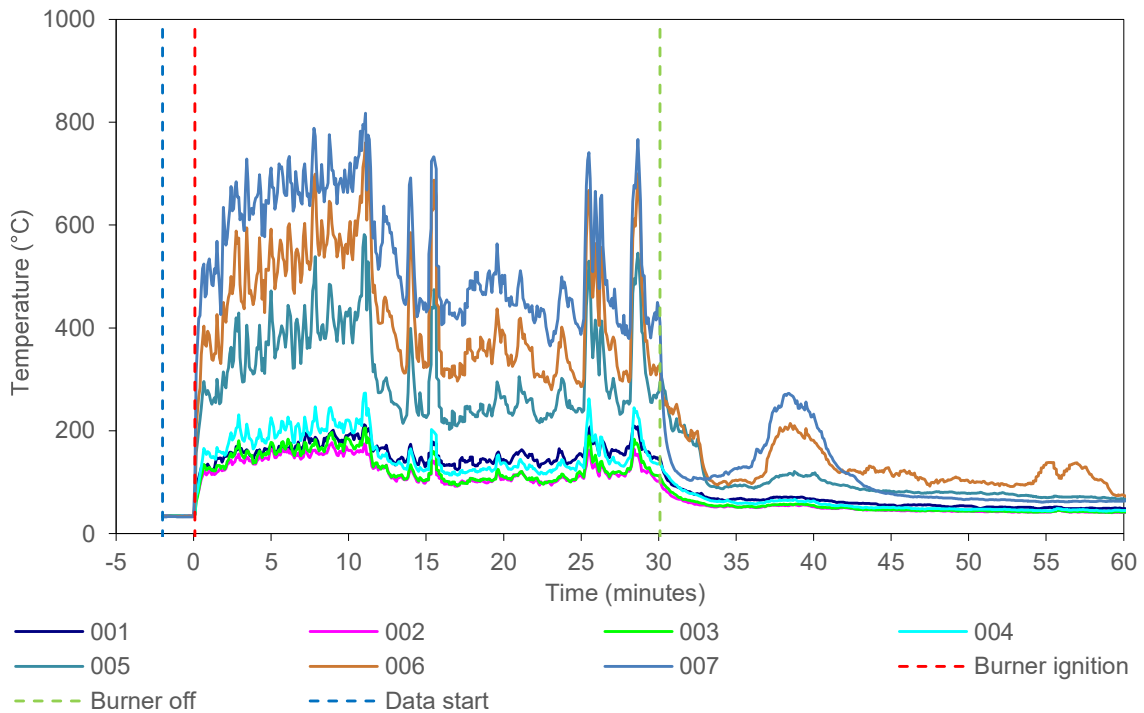

Figure 3 External temperature data collected by thermocouples placed 60 mm from the front face of the specimen - in-line with the burner

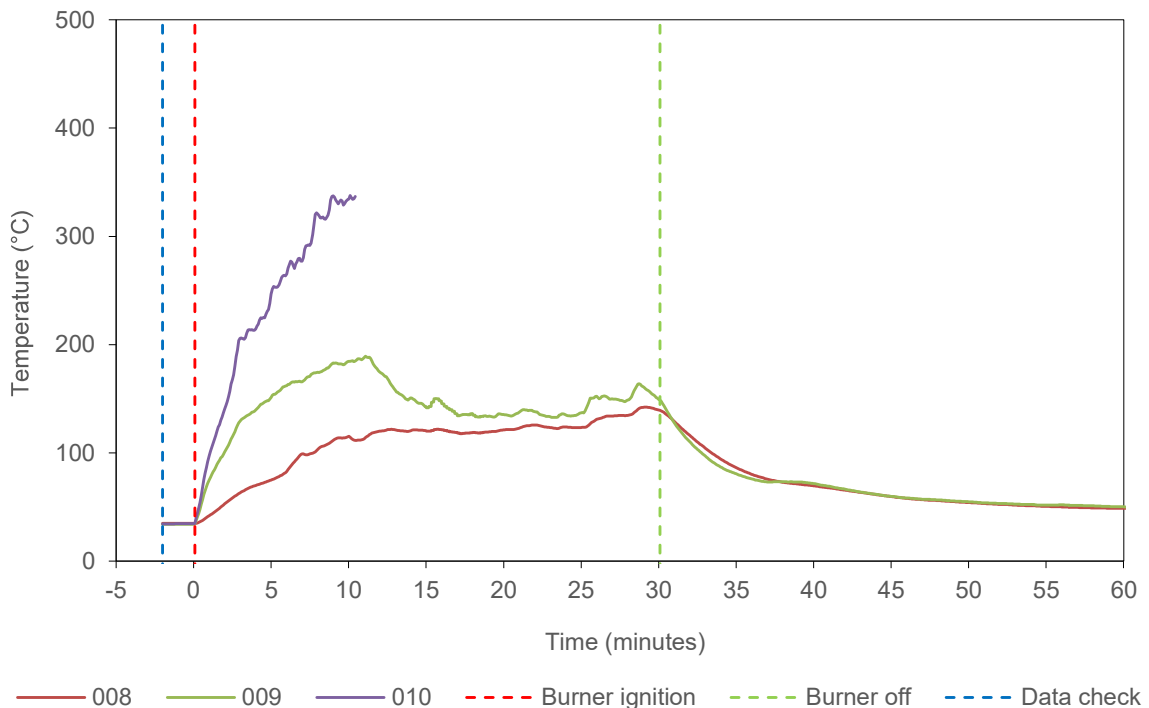

Figure 4 External temperature data collected by plate thermocouples in-line with ACP, above and below, respectively - in-line with the burner¹

¹ Thermocouple 010 malfunctioned during the test, thus causing spikes during the data collection process.

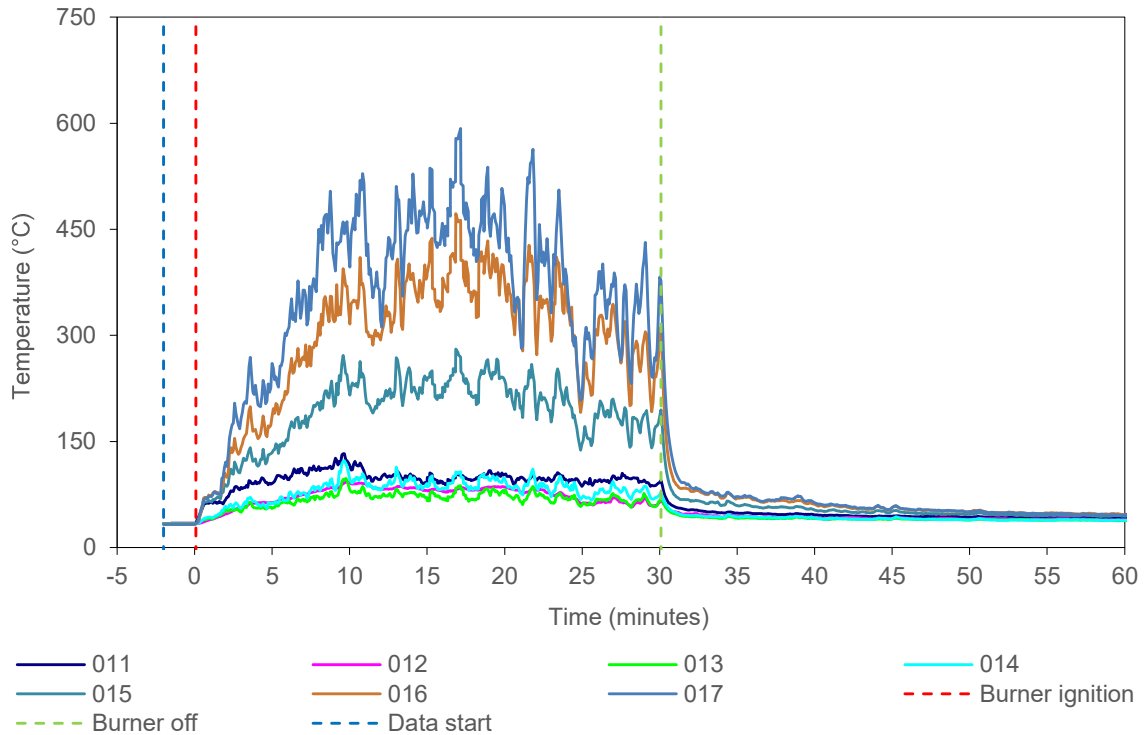

Figure 5 External temperature data collected by thermocouples placed 60 mm from the front face of the specimen – central module

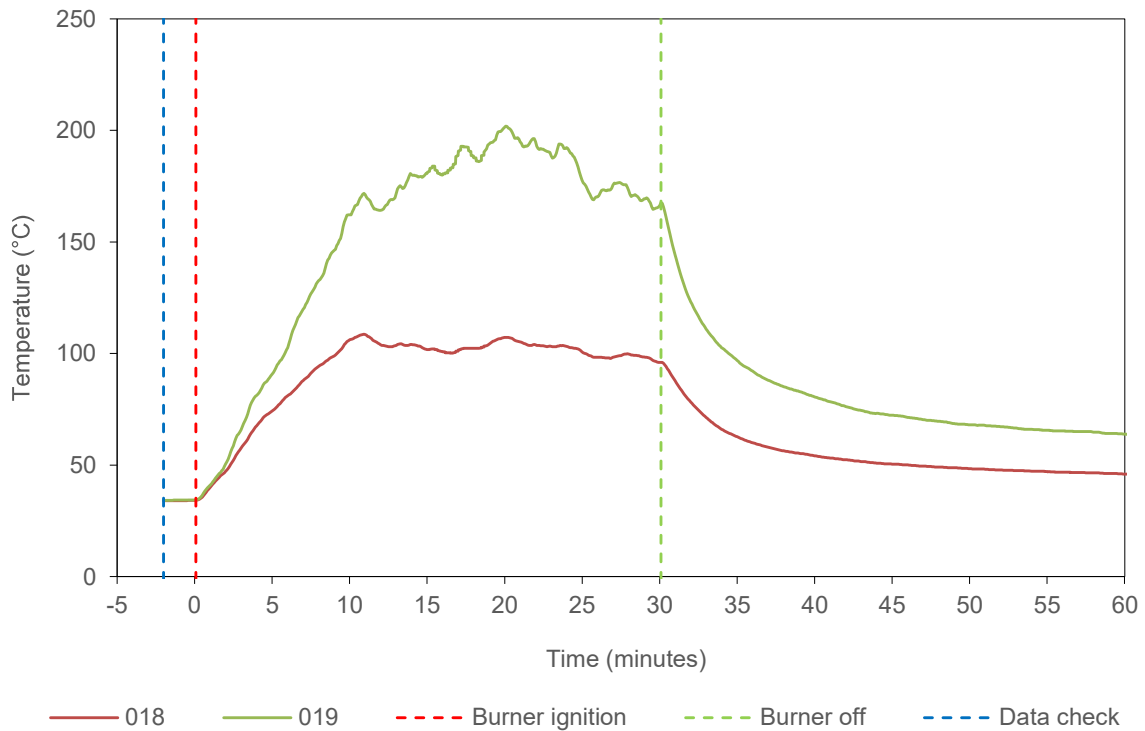

Figure 6 External temperature data collected by thermocouples in-line with ACP, above and below, respectively – central module

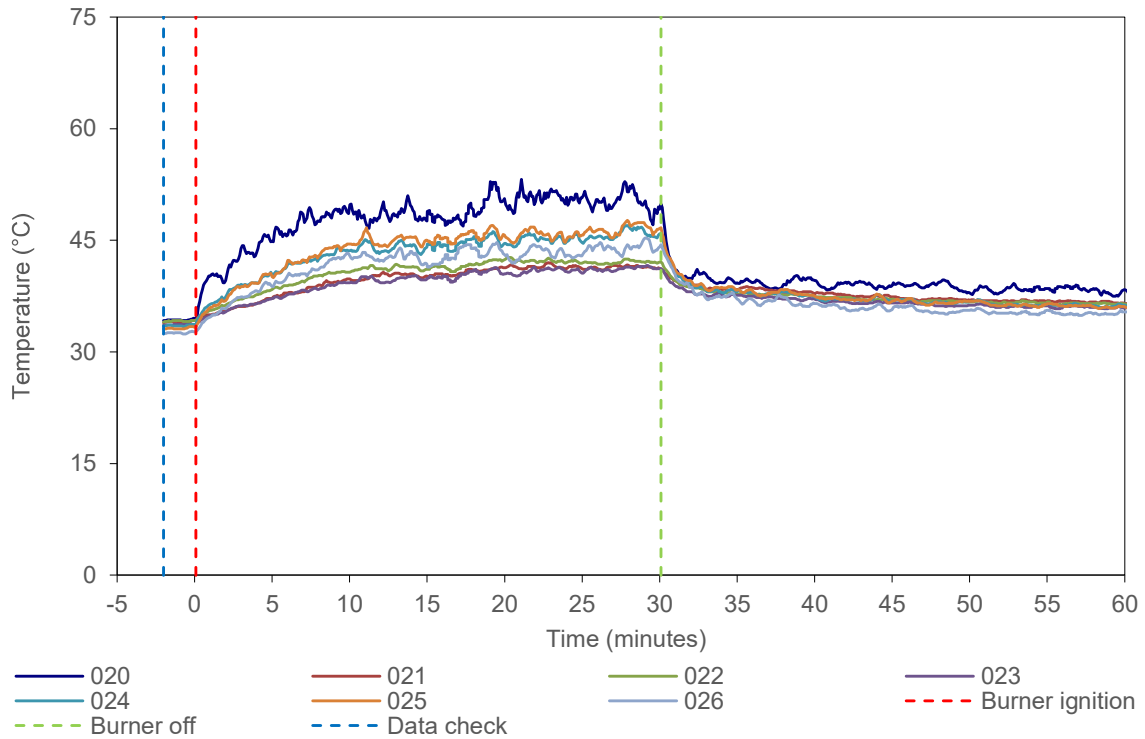

Figure 7 External temperature data collected by thermocouples placed 60 mm from the front face of the specimen – away from burner

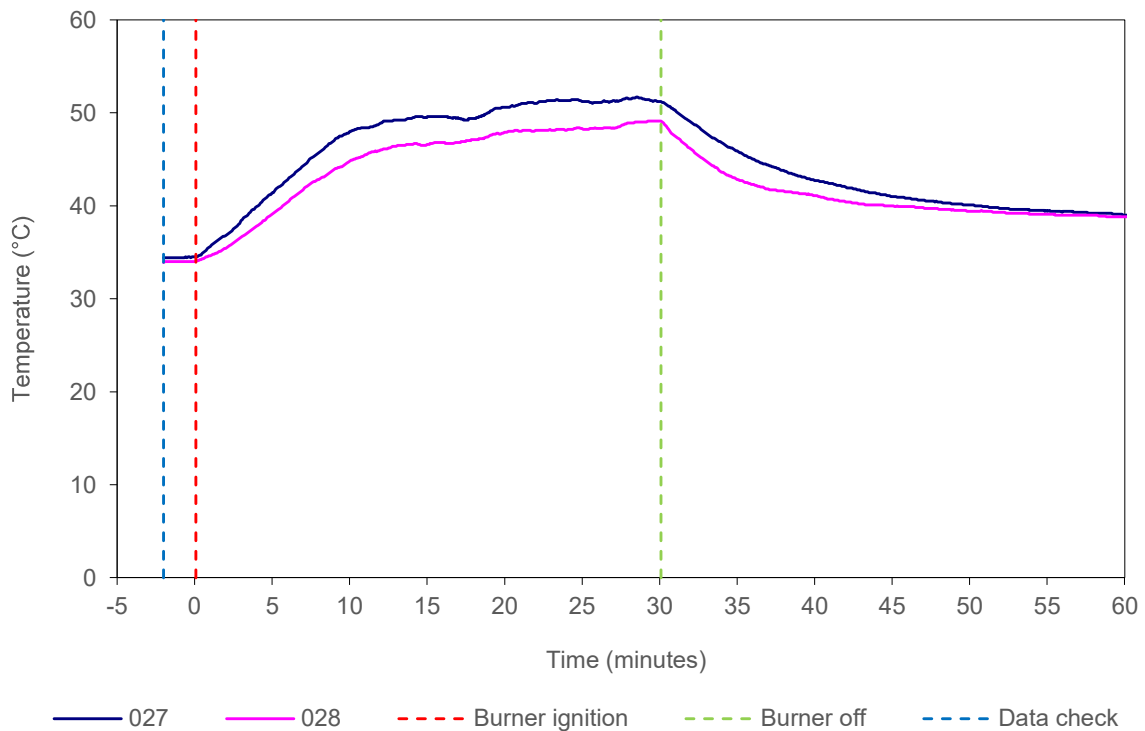

Figure 8 External temperature data collected by thermocouples in-line with ACP, above and below, respectively – away from burner

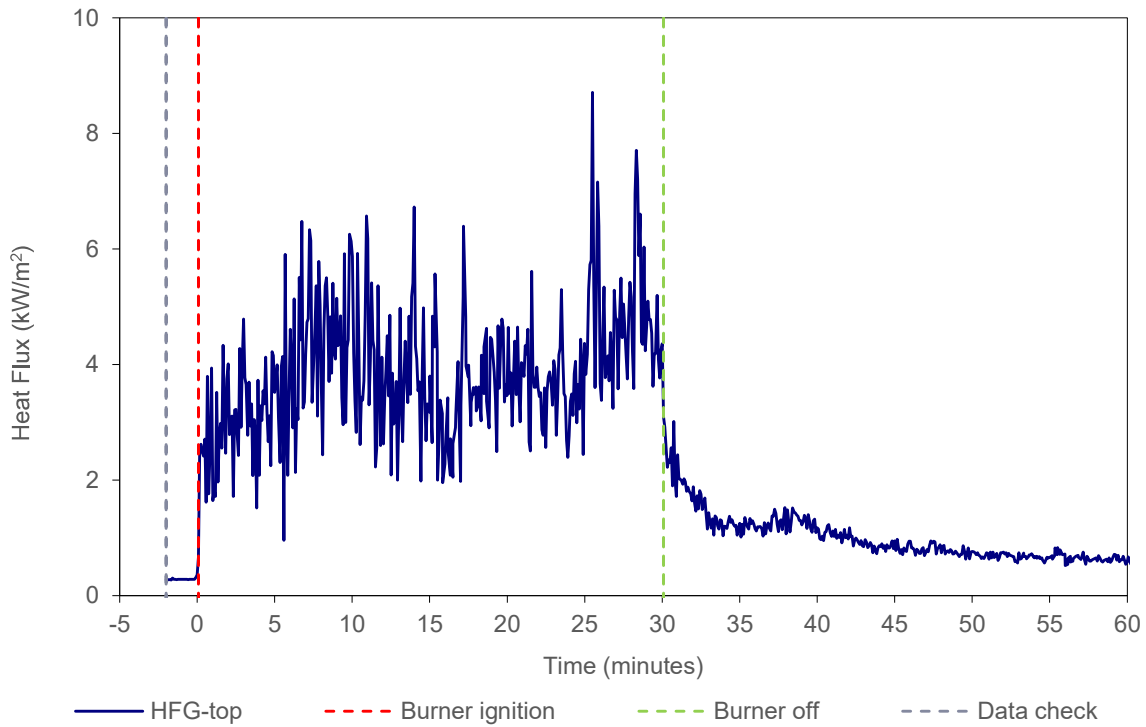

Figure 9 Heat flux data collected by heat flux gauge at the top of the specimen above the burner

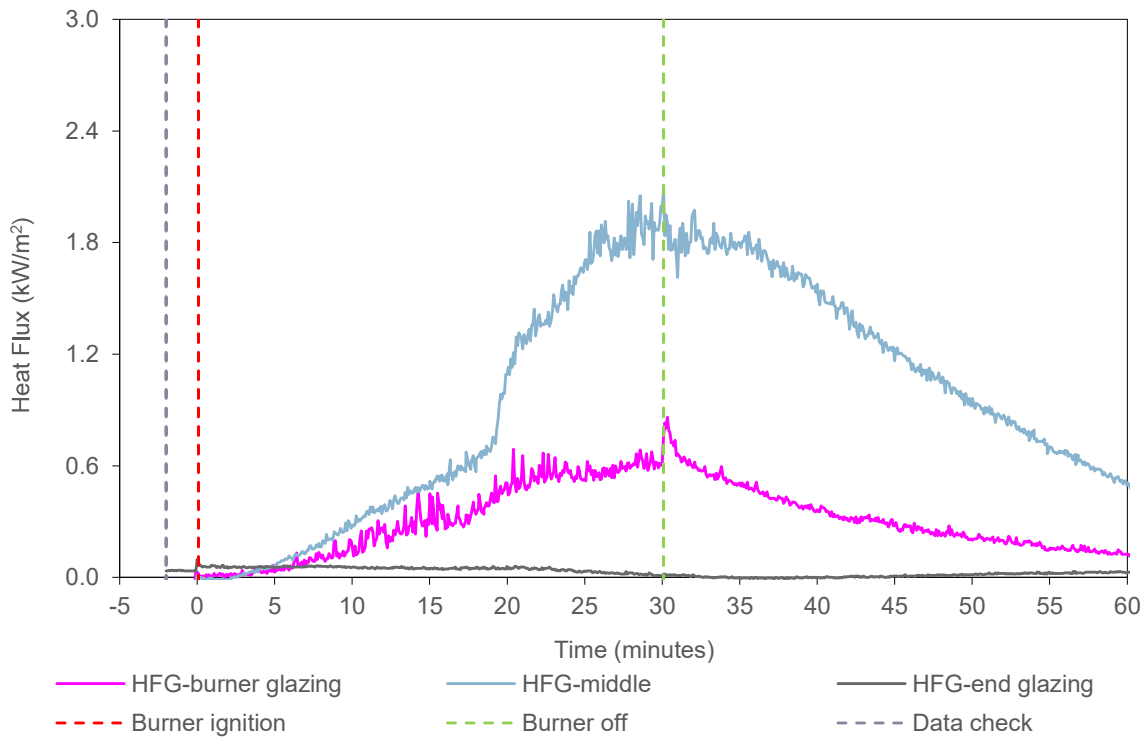

Figure 10 Heat flux data collected by heat flux gauges behind the glazing units



Figure 11 Designation of section for the test observations

Table 4 shows the observations of any significant behaviour of the specimen during the test. Figure 11 shows the panel and glazing designations sighted in the observations.

Video recordings were also taken of the test from approximately 4 metres in front of the specimen and from 2 metres on a 45 ° angle behind the specimen. A copy of the video recording is available upon request from the test sponsor or by contacting Cladding Safety Victoria. The video of the test should be viewed in conjunction with the contents of this report.

Table 4 Test observations

Time		System	Observation
Min	Sec		
-2	00	-	Data collection started.
0	00	-	The reaction to fire test was started with the burner ignited with a heat output set at 300 kW.
0	50	A1	The face of the lower side of panel started to discolour.
1	05	B1	The face of the lower side of panel started to discolour.
1	10	A2	The face discolouration had spread on to the mid-section of the panel.
1	38	A1	A sudden discharge of gas occurred from the panel front face.
1	57	A/B	Smoke started to escape from the vertical joint between the module.
2	23	B1	Flames spread across the bottom horizontal joint.
2	43	C	Smoke started to escape from the horizontal joint between the panels.
2	55	A1	Molten debris started to drip from the panel.
4	30	A/B	Molten debris started to drip from the vertical joint between the modules.
5	40	A1	Flaming on the unexposed side.
6	40	A1/A2	Flames started to spread across the east edge of the panels.
7	06	A2	A sudden discharge of gas occurred from the panel front face.
7	28	B1	Molten debris started to drip from the mid-section of the panel.
9	44	A3	Independent flaming at the bottom edge of the glazing.
10	14	A3	The flaming had died off.
10	50	A2	The east edge of the panel had opened up.
11	21	A2	The face of the panel had an opening from the exposed to unexposed side of the panel.
12	17	A3	The bottom east corner of the glazing was flaming independently.
13	01	A3	The independent flaming had spread across the bottom of the glazing.
13	28	A3	The flaming had stopped.
13	44	A3	The independent flaming restarted.
14	17	A2	Flames started to punch through the horizontal panel joint.
15	04	A3	The flames from the east edge were spreading upwards.
16	00	A2	The flames escaping from the horizontal joint increased in intensity.
18	44	A3	The flames had penetrated into the layer between the glazing.
20	48	A3	The glazing had cracked.
22	14	B2	The top east edge of the panel was flaming independently.
26	18	A3	The glazing layers started to open up.
30	00	-	The burner was turned off.
30	15	A/B 1/2	The panels still had independent flaming.
32	48	A2	The flames from the horizontal joint of the panel had died off.
35	00	A3	The fire on the east edge of the glazing had died off.
36	54	A2	Gas was released from the panel.

Time		System	Observation
Min	Sec		
38	39	A2	More gas was released from the panel.
47	55	A3	Some portion of the glazing had broken off.
58	40	A/B 1/2	Most of the independent flaming had died off, leaving some intermittent flaming.
60	00	-	The test was ended.

5. Application of test results

5.1 Test limitations

The results of these fire tests may be used to directly assess fire hazard, but it should be recognised that a single test method will not provide a full assessment of fire hazard under all fire conditions.

These results only relate to the behaviour of the specimen of the element of construction under the particular conditions of the test. They are not intended to be the sole criteria for assessing the potential fire performance of the element in use, and they do not necessarily reflect the actual behaviour in fires.

5.2 Variations from the tested specimen

This report details methods of construction, the test conditions and the results obtained when the specific element of construction described here was tested following the procedure outlined in Table 3. Any significant variation with respect to size, construction details, loads, stresses, edge or end conditions is not addressed by this report.

It is recommended that any proposed variation to the tested configuration should be referred to the test sponsor. They should then obtain appropriate documentary evidence of compliance from Warringtonfire or another accredited testing authority.

5.3 Uncertainty of measurements

Because of the nature of reaction to fire testing and the consequent difficulty in quantifying the uncertainty of measurements obtained from a reaction to fire test, it is not possible to provide a stated degree of accuracy of result.

Appendix A Drawings of test assembly

The drawings of the test assembly in Figure 12 to Figure 26 were provided by the representatives of Warringtonfire. Dimensions, unless specified, are in mm.

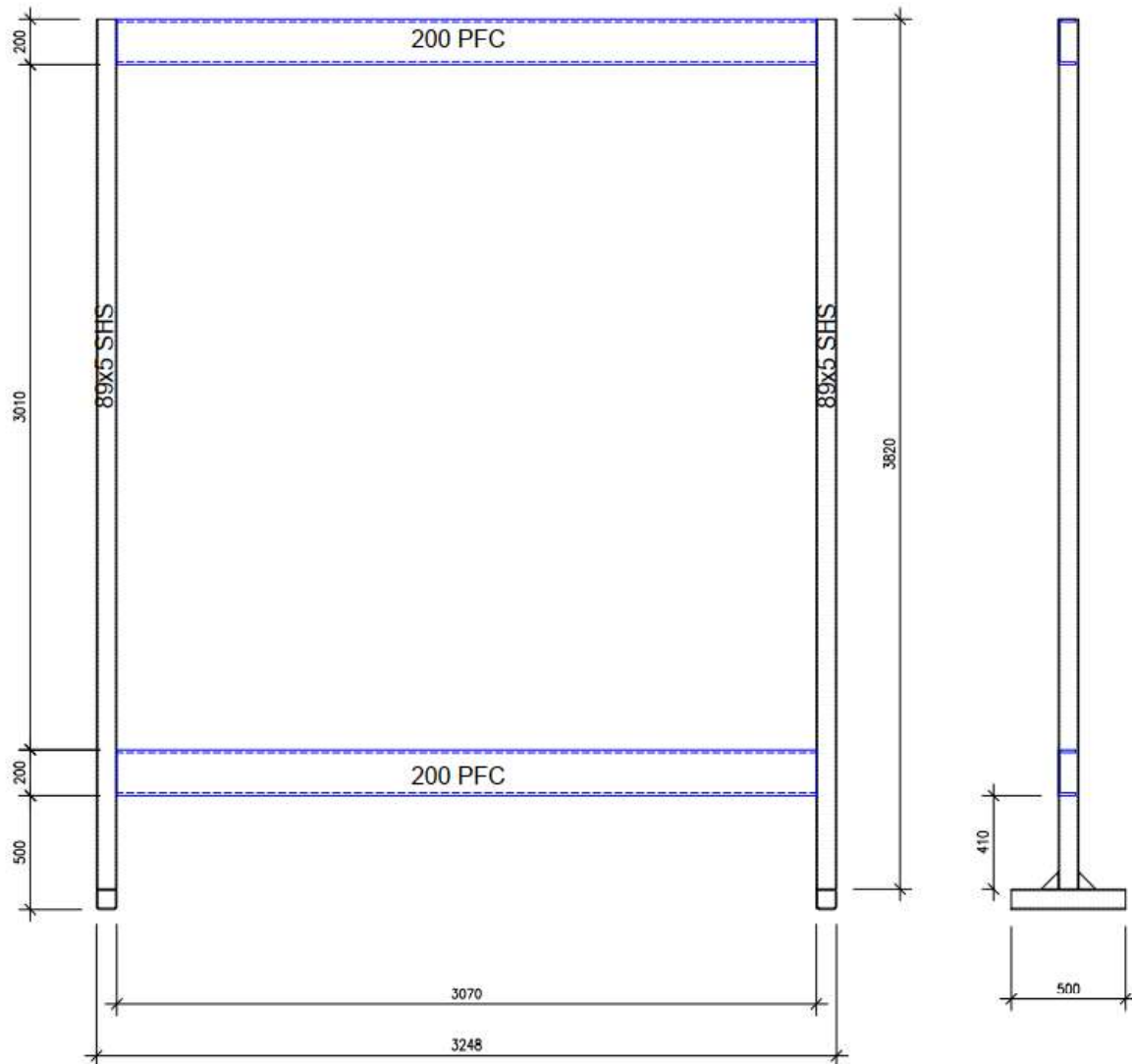

Figure 12 Elevation of rig support



Figure 13 System assembly – Front view

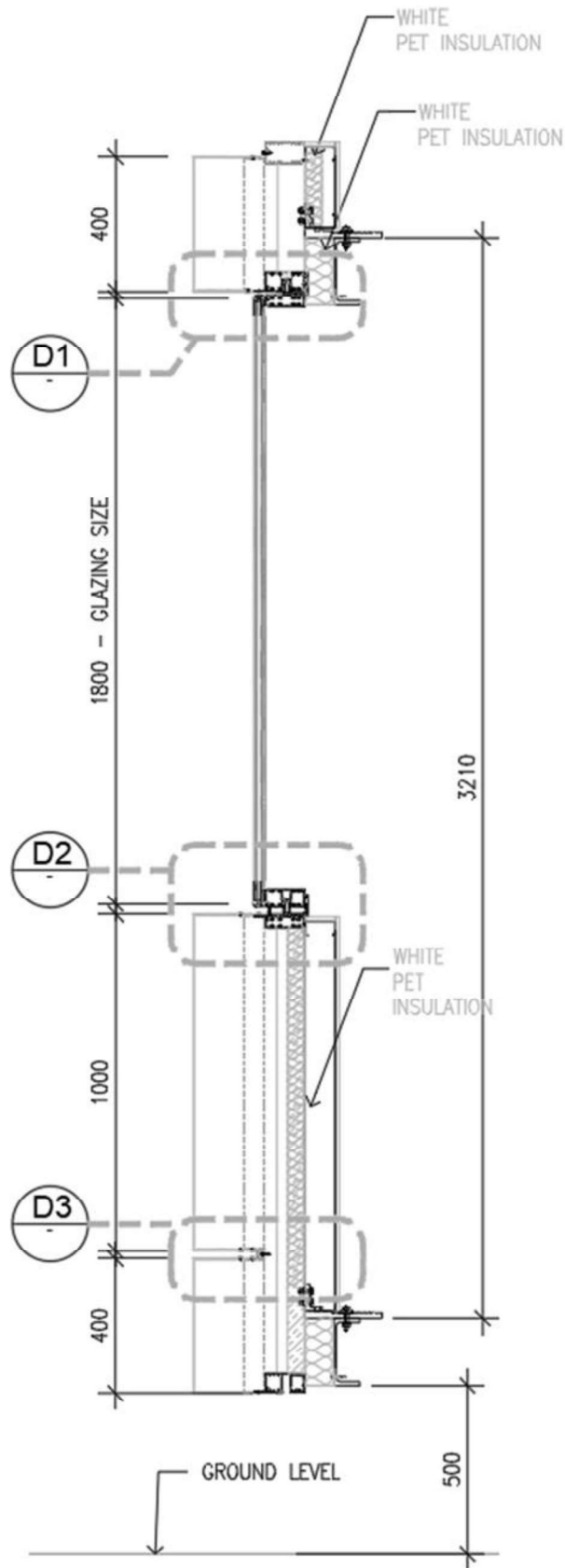

Figure 14 System assembly – vertical cross-sectional view X1

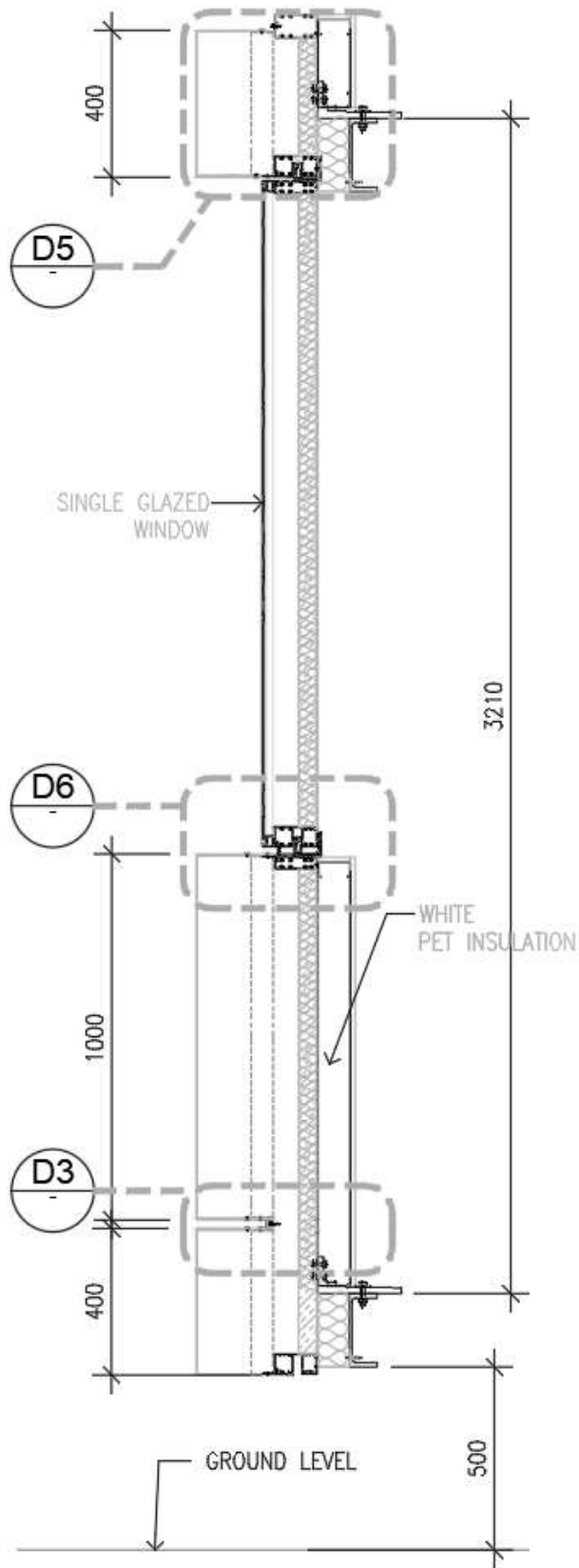

Figure 15 System assembly – vertical cross-sectional view X2

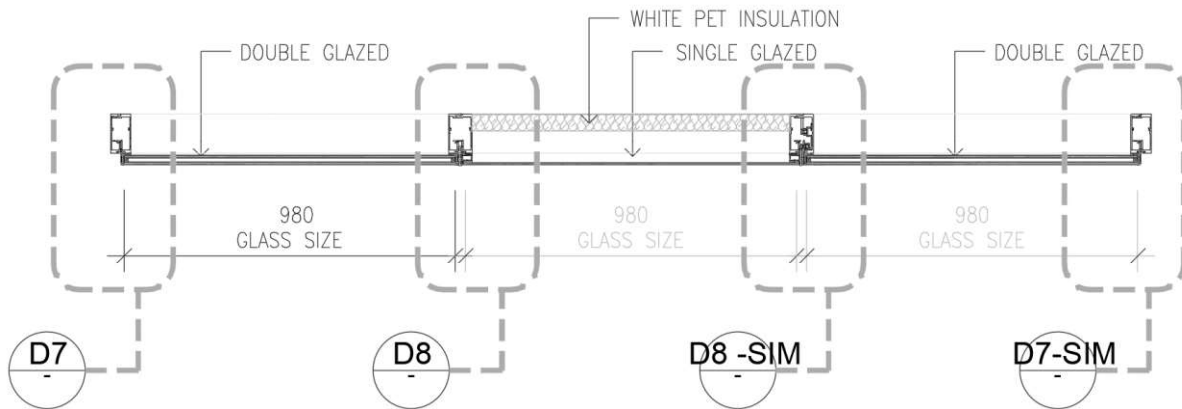

Figure 16 System assembly – horizontal mid height cross-sectional view

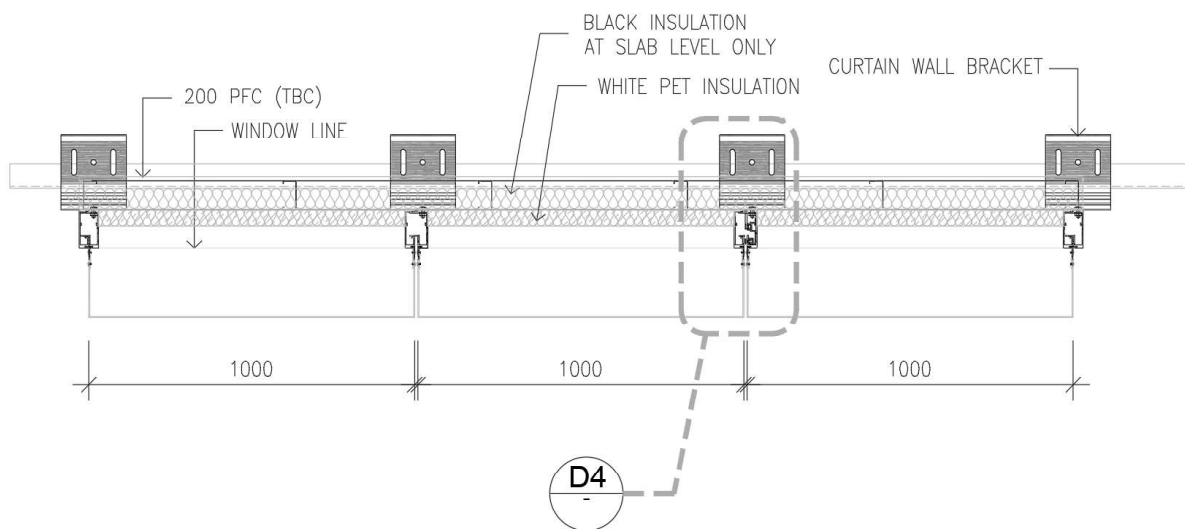

Figure 17 System assembly –top view

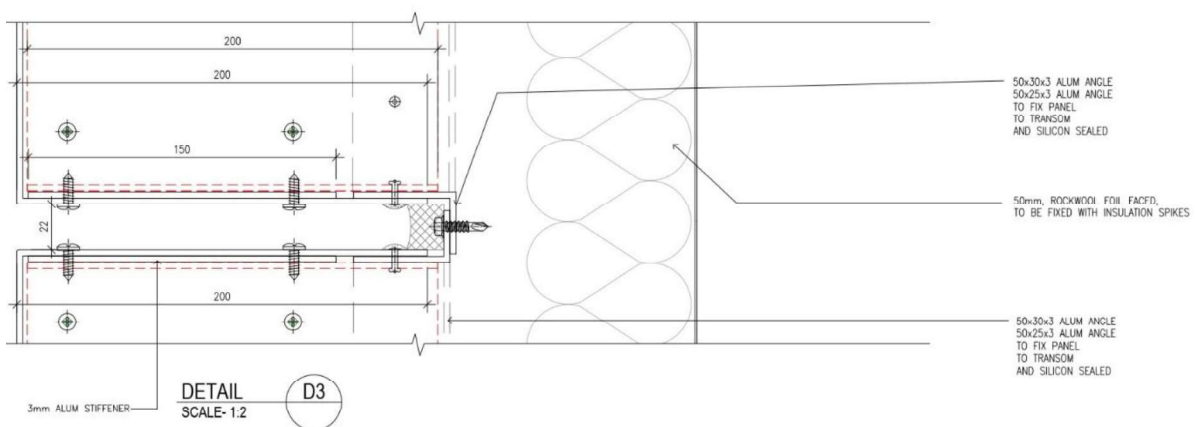

Figure 18 System assembly – Vertical cross-sectional view D3

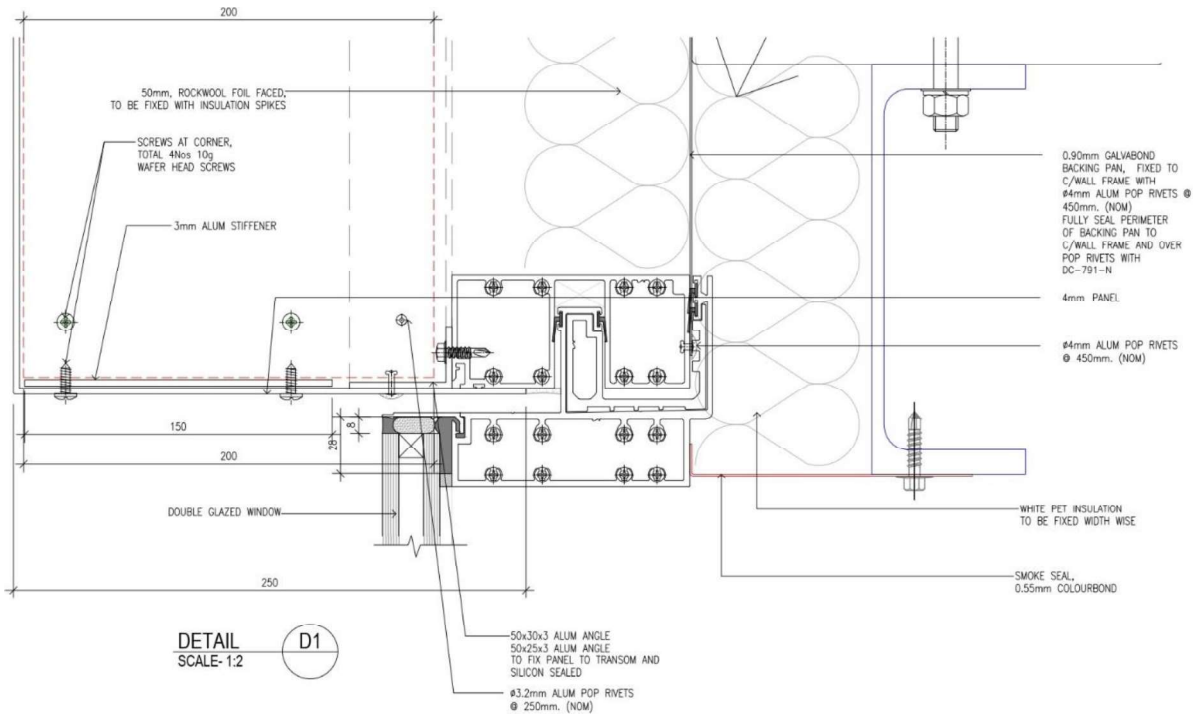

Figure 19 System assembly – Vertical cross-sectional view D1

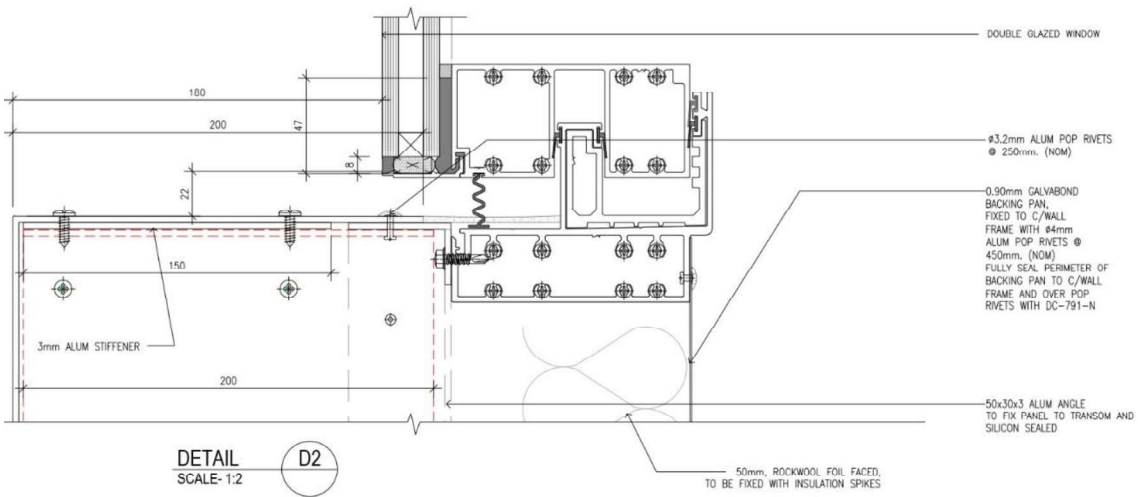

Figure 20 System assembly – Vertical cross-sectional view D2

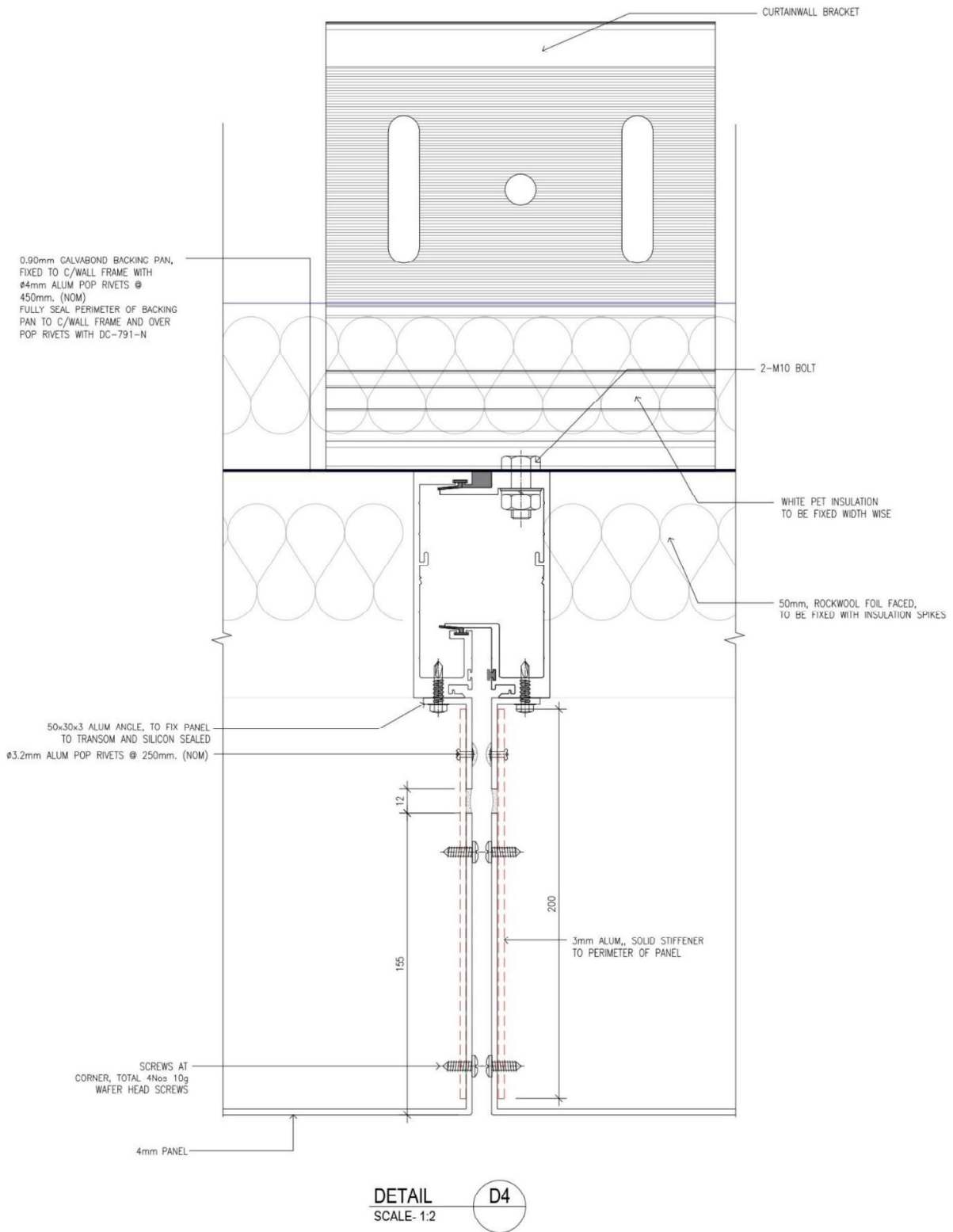

Figure 21 System assembly – Horizontal cross-sectional view D4

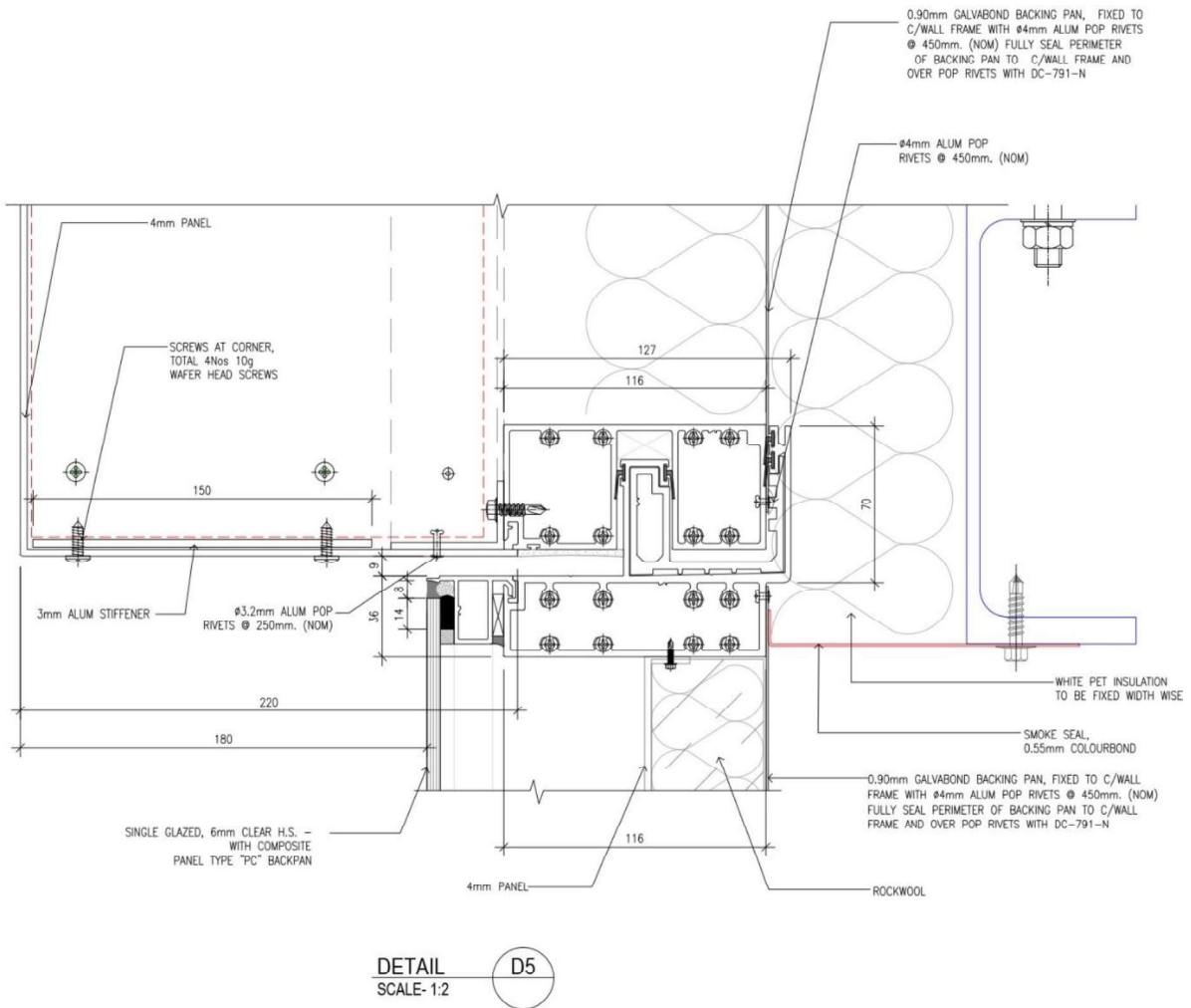

Figure 22 System assembly – Vertical cross-sectional view D5

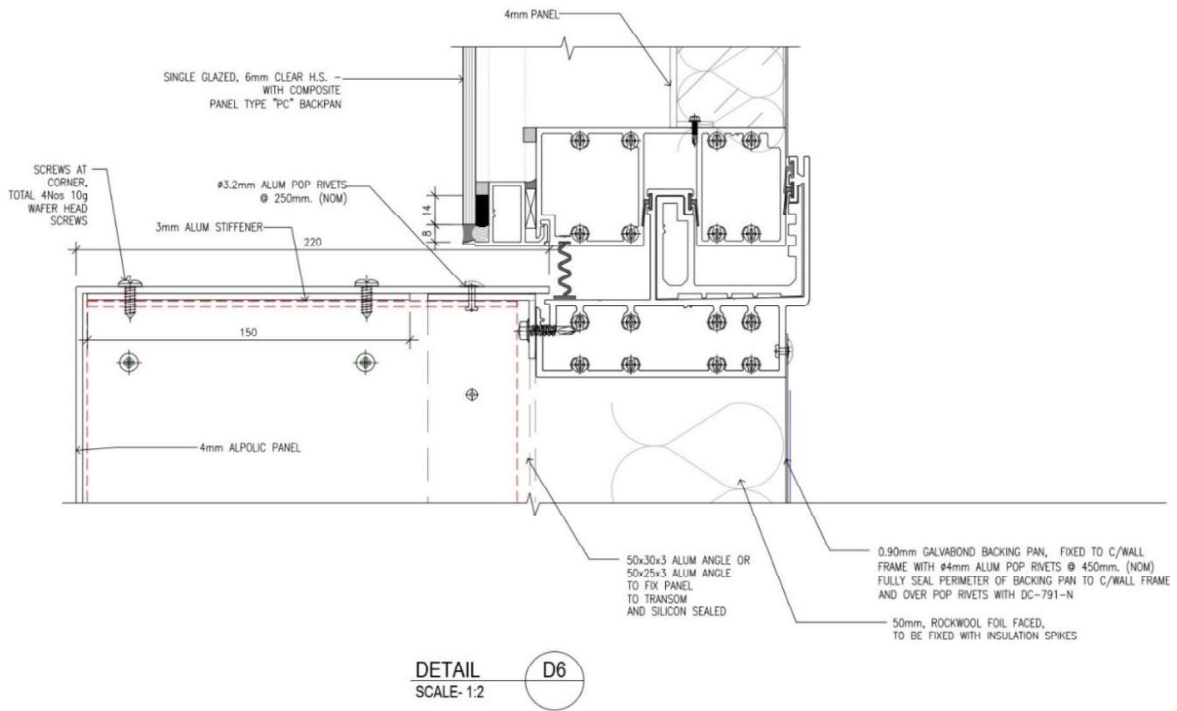

Figure 23 System assembly – Vertical cross-sectional view D6

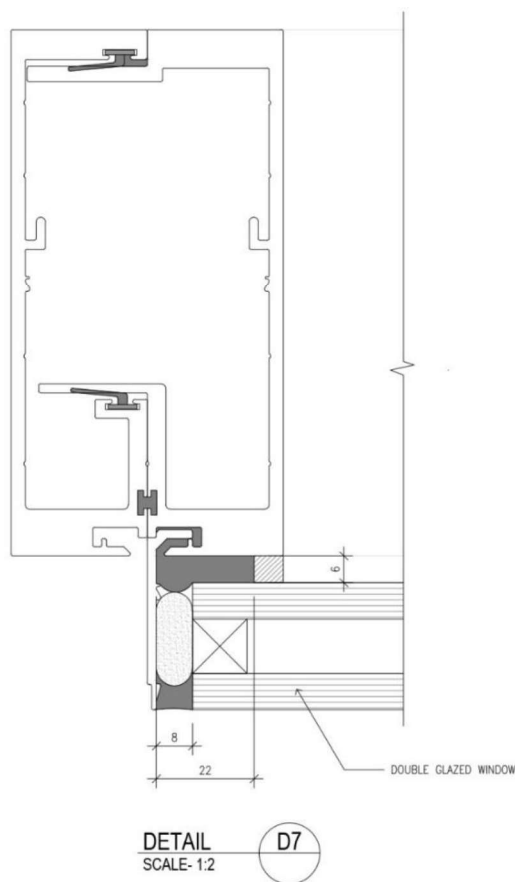

Figure 24 System assembly – vertical cross-sectional view D7

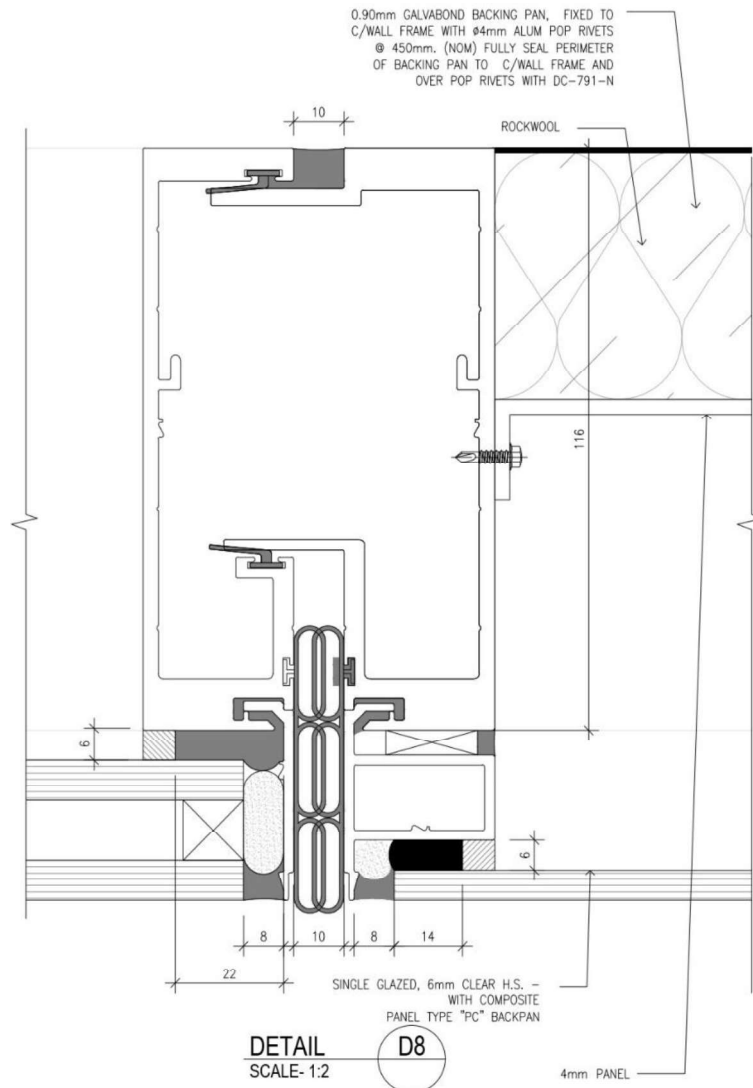

Figure 25 System assembly – vertical cross-sectional view D8

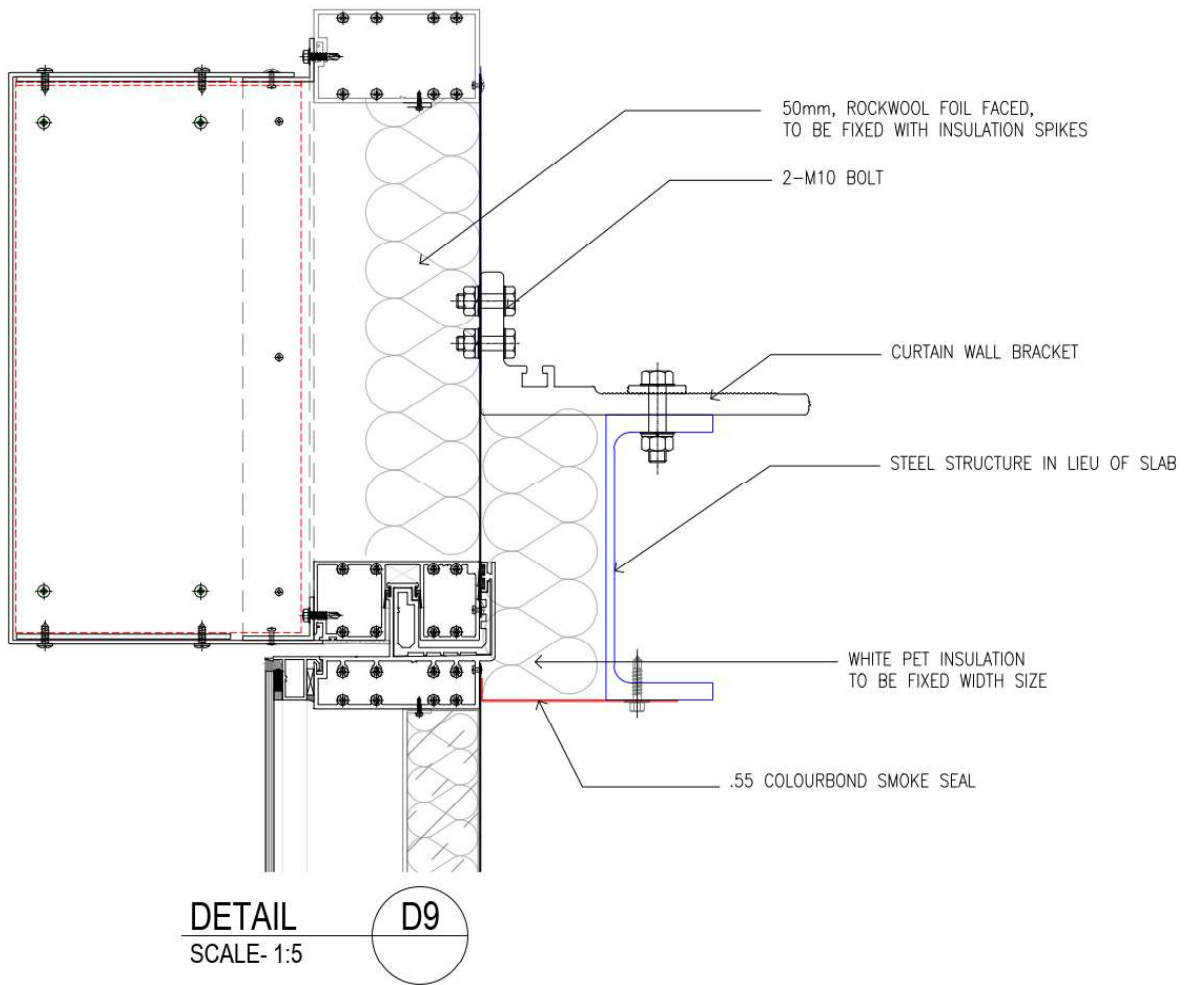

Figure 26 System assembly – vertical cross-sectional view D9

Appendix B Photographs



Figure 27 The specimen (exposed side) before the reaction to fire test



Figure 28 The specimen (unexposed side) before the reaction to fire test



Figure 29 The specimen 1 minute 4 seconds into the test (burner output at 300 kW)



Figure 30 The specimen 3 minutes 3 seconds into the test (burner output at 300 kW)



Figure 31 The specimen 5 minutes 35 seconds into the test (burner output at 300 kW)



Figure 32 The specimen 9 minutes 1 second into the test (burner output at 300 kW)



Figure 33 The specimen 12 minutes 33 seconds into the test (burner output at 300 kW)



Figure 34 The specimen 15 minutes into the test (burner output at 300 kW)



Figure 35 The specimen 18 minutes 21 seconds into the test (burner output at 300 kW)



Figure 36 The specimen 22 minutes 14 seconds into the test (burner output at 300 kW)



Figure 37 The specimen 25 minutes into the test (burner output at 300 kW)



Figure 38 The specimen 28 minutes 26 seconds into the test (burner output at 300 kW)



Figure 39 The specimen 30 minutes 5 seconds into the test (burner off)



Figure 40 The specimen 33 minutes 7 seconds into the test (burner off)



Figure 41 The specimen 56 minutes 2 seconds into the test (burner off)



Figure 42 The specimen at end of test – exposed side



Figure 43 The specimen at end of test – unexposed side

Appendix C Chemical analysis results



UNSW RESEARCH INFRASTRUCTURE

Chemical Consulting Laboratory

Mark Wainwright Analytical Centre
UNSW Sydney NSW 2052 Australia

T: +61(2) 9348 1400 | E: ccl@unsw.edu.au
W: www.analytical.unsw.edu.au/contact-us/commercial-consulting
ABN 57 195 873 179 | CRICOS Provider Code 00098G

Test Report



Prepared by:

ANALYSIS OF CLADDING SAMPLES

For

Company: Warrington Fire
Contact: 
Date: 22 February 2024

Project No: 24021

Prepared by: 
Approved by: 

COMMERCIAL-IN-CONFIDENCE

Any use of the Test Report, use of any part of it, use of the names University of New South Wales or UNSW, use of the name of any Unit of UNSW, or use of the name of the consultant in direct or indirect advertising or publicity is strictly forbidden.



Analysis of Cladding Samples

1. SAMPLES

One envelope containing three ACP cores was received for analysis. The samples were identified as follows:

CCL sample coding	Client sample coding
24021-1	#1 - 100%
24021-2	#2 - 100%

CCL has been asked to identify the polymer and the filler (s) in the samples by FT/IR, quantitate and identify the mineral filler in the samples and classify them in accordance with the ICA cladding scheme.

2. METHODOLOGY AND RESULTS

The aluminium metals were removed from the ACPs cladding polymer, and the flat surface of the polymer sample was abraded to remove any surface adhesive. The surface of the sample was analysed directly by FTIR. The FT-IR spectra are presented in Figures 1-3.

The core of the samples was then ashed to determine their percentage mineral content (Table 1). If sufficient (>0.5 g) ash was found in the sample, it was analysed for elemental composition by X ray fluorescence spectroscopy. Results are presented in Table 2.

Table 1 Ash content of 24021-1-3

Sample coding	Ash content (w/w%)
24021-1	3.3
24021-2	3.0

3. CONCLUSIONS

The cladding sample #1 consisted of 3.3% inert material and approximately 96% polyethylene polymer.

The cladding sample #1 is classified as ICA category A.

The cladding sample #2 consisted of 3.0% inert material and approximately 97% polyethylene polymer.

The cladding sample #2 is classified as ICA category A.

The ICA Classification assigned is correct as per the September 2020 revision of the ICA Guidelines.

The reader is reminded that we can only analyse and classify the content of samples actually presented to us. We can offer no guarantee that this composition or classification is valid for cladding as a whole, because some types of cladding can be inhomogeneous, and a sample may not be representative of the cladding as a whole. Anyone using our results should consider these sampling issues and uncertainties before they generalise the results we present to anybody of cladding as a whole.

Dominic D'adam BSc/BE (Hons)
Senior Technical Officer
Chemical Consulting Laboratory
Mark Wainwright Analytical Centre, UNSW
22 February 2024



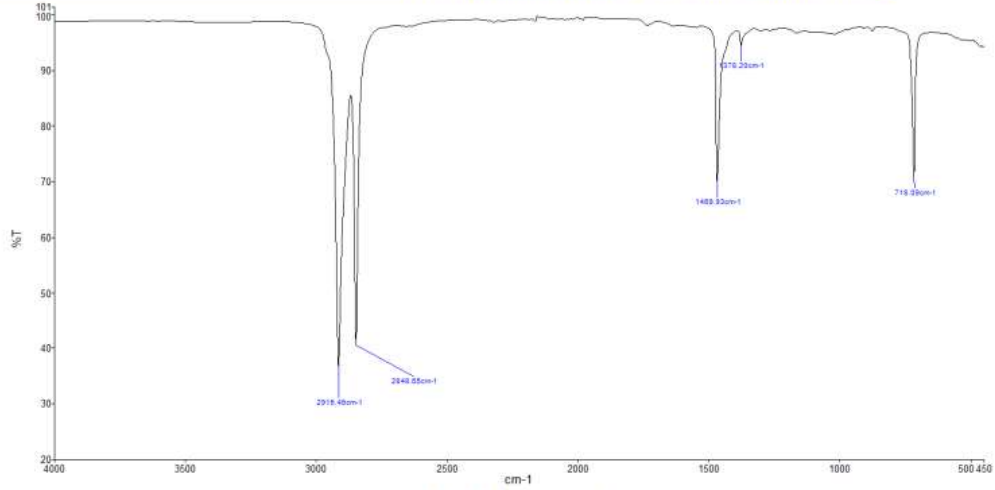

Figure 1. FT-IR spectrum of sample #1

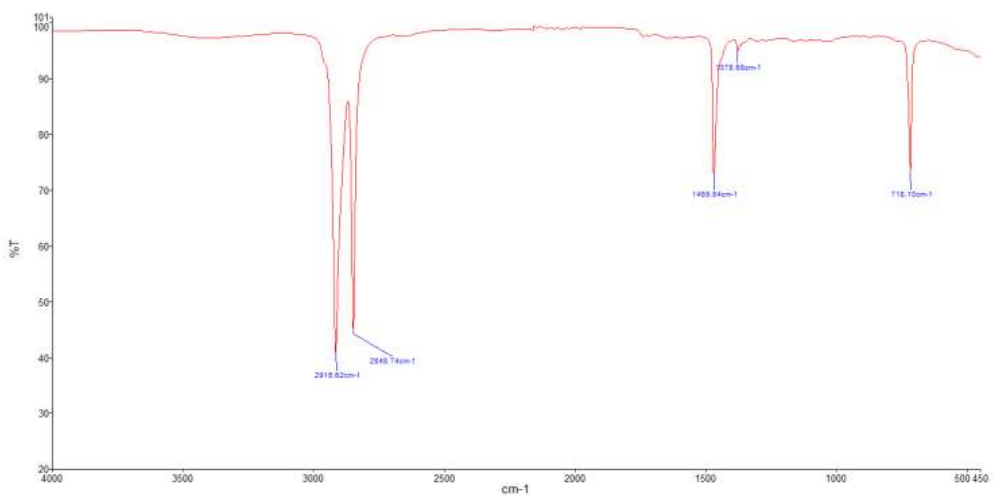

Figure 2. FT-IR spectrum of sample #2



WARRINGTONFIRE AUSTRALIA

A Jensen Hughes Company

Warringtonfire Australia Pty Ltd
ABN 81 050 241 524

Perth

Suite 4.01, 256 Adelaide Terrace
Perth WA 6000
Australia
T: +61 8 9382 3844

Canberra

Unit 10, 71 Leichhardt Street
Kingston ACT 2604
Australia
T: +61 2 6260 8488

Melbourne

Level 4, 152 Elizabeth Street
Melbourne Vic 3000
Australia
T: +61 3 9767 1000

Sydney

Suite 802, Level 8, 383 Kent Street
Sydney NSW 2000
Australia
T: +61 2 9211 4333

Brisbane

Suite B, Level 6, 133 Mary Street
Brisbane Qld 4000
Australia
T: +61 7 3238 1700

Melbourne – NATA accredited laboratory

409-411 Hammond Road
Dandenong South Vic 3175
Australia
T: +61 3 9767 1000

General conditions of use

The data, methodologies, calculations and results documented in this report specifically relate to the tested specimen/s and must not be used for any other purpose. This report may only be reproduced in full. Extracts or abridgements must not be published without permission from Warringtonfire.

All work and services carried out by Warringtonfire are subject to, and conducted in accordance with our standard terms and conditions. These are available on request.